

INSTALLATION INSTRUCTIONS

A guide for qualified electricians

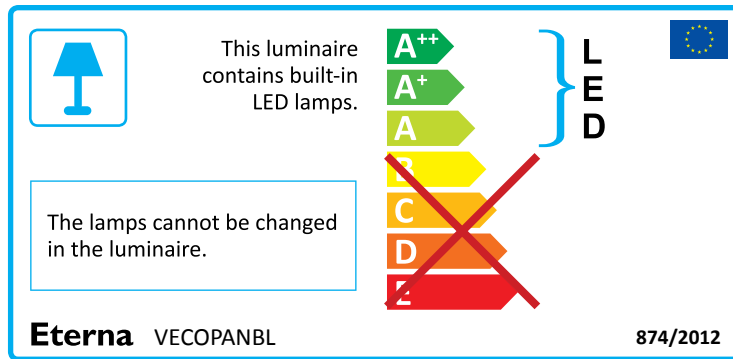

EVENTUALLY, YOU MAY WANT TO REPLACE THIS PRODUCT:

Regulations require the recycling of Waste from Electrical and Electronic Equipment (European "WEEE Directive" effective August 2005—UK WEEE Regulations effective 2nd January 2007). Environment Agency Registered Producer: WEE/GA0248QZ.

WHEN YOUR PRODUCT COMES TO THE END OF ITS LIFE OR YOU CHOOSE TO REPLACE IT, PLEASE RECYCLE IT WHERE FACILITIES EXIST - DO NOT DISPOSE WITH HOUSEHOLD WASTE.

CLEANING:

Clean this fitting only with a soft dry cloth.

Do not use any chemical or abrasive cleaners.

IF YOU EXPERIENCE PROBLEMS:

If you believe your product is defective, please return it to the place where you bought it. Our Technical Team will gladly advise on any Eterna Lighting product, but may not be able to give specific instructions regarding individual installations.

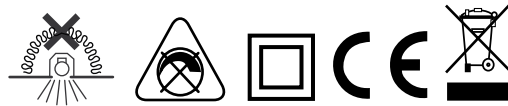

Email: sales@eterna-lighting.co.uk / technical@eterna-lighting.co.uk

Visit our website: www.eterna-lighting.co.uk

Made in China

Issue 0819



Pack contents:

1 x LED Panel Light
1 x Driver

Model:

VECOPANBL

600mm x 600mm Economy Backlit LED Panel

These instructions are provided as a guideline to assist you.

**PLEASE READ THESE INSTRUCTIONS BEFORE INSTALLATION
AND RETAIN FOR FUTURE REFERENCE**

READ THIS FIRST:

Check the pack and make sure you have all of the parts listed on the front of this booklet. If not, contact the outlet where you bought this product.

This product must be installed by a competent person in accordance with the current building and IEE wiring regulations.

As the buyer, installer and/or user of this product it is your own responsibility to ensure that this fitting is fit for the purpose for which you have intended it. Eterna Lighting cannot accept any liability for loss, damage or premature failure resulting from inappropriate use.

Switch off the mains before commencing installation and remove the appropriate circuit fuse or lock off MCB.

Disconnect the driver from the electrical supply before flash or high voltage testing.

Do not connect to a circuit which also has inductive loads connected; switching of inductive loads will generate spikes which may damage electronic components within your driver.

This unit is suitable for indoor use only.

This product is suitable for use in living areas; it is **not** suitable for bathroom zones 0, 1, 2, or other areas where contact with moisture is likely (see diagram opposite and current IEE Wiring Regulations for details).

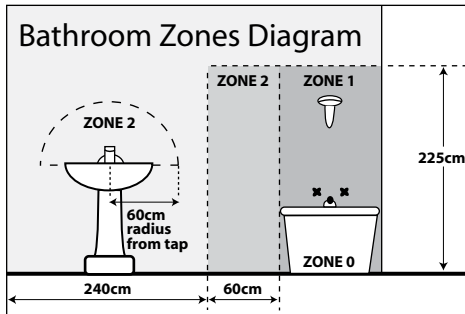

This product is designed for permanent connection to fixed wiring: this must be a suitable circuit (protected with the appropriate MCB or fuse).

This product is suitable for installation on surfaces with normal flammability e.g. wood, plasterboard and masonry. It is not suitable for use on highly flammable surfaces (e.g. polystyrene, textiles).

If installing / mounting a light fitting to a plastic ceiling, you must seek advice from the ceiling manufacturer regarding the type and specification of light fittings that may be used.

Before making fixing hole(s), check that there are no obstructions hidden beneath the mounting surface such as pipes or cables.

Make sure that the fixings are strong enough to support the considerable weight of the fitting and hold it rigidly.

Do not cover the fitting with any insulating materials.

The fitting must be positioned so that there is at least 0.5m (500mm) between the LED and any illuminated surface.

Do not attach to surfaces which are damp, freshly painted or otherwise electrically conductive (e.g. metallic surfaces).

When making connections ensure that the terminals are tightened securely and that no strands of wire protrude. Check that the terminals are tightened onto the bared conductors and not onto any insulation.

This product is not intended to be used by children and persons with sensory, physical and/or mental impairments that would prevent them from using it safely.

You are advised at every stage of your installation to double-check any electrical connections you have made. After you have completed your installation there are electrical tests that should be carried out, these tests are specified in the current IEE wiring and building regulations.

INSTALLATION:

Switch off the mains before commencing installation.

- 1) Connect using lead provided or remove terminal cover from input side of the driver and remove the pre-wired lead.
- 2) Make connections to the electrical supply in accordance with the following code:

Live – Brown wire marked (L)
Neutral – Blue wire marked (N)

This product is double insulated - do not connect to earth.

- 3) Ensure the connections in the terminal are secure and replace the terminal cover.
- 4) Install the fitting into position within the suspended ceiling, laying the unit to rest on the T-bar section (See Fig 1. for instructions).
- 5) Suspension of the panel can be achieved by purchasing the suspension kit: **SUSPACK**. (See Fig 2 for instructions).
- 6) Restore power and the unit should illuminate.

LAMP REPLACEMENT:

The light source of this luminaire is not replaceable; when the light source reaches its end of life the whole luminaire shall be replaced.

LED LAMP SPECIFICATIONS:

Luminaire lumens (with diffuser)	3450 lm
Lumens from chip (no diffuser)	3900 lm
Useful lumens	3300 lm
Rated Wattage	36W
Rated luminous flux	3300 lm
Nominal life time of the lamp	30,000 hrs
Colour temperature	4000K
Number of switching cycles before premature lamp failure	15,000
Warm-up time up to 60% of the full light output	0.5s
Dimmable	No
Nominal beam angle	110°
Rated power	36W
Rated lamp lifetime	30,000 hrs
Lamp power factor	>0.9
Lumen maintenance factor at end of nominal life	>70%
Starting time	<0.5s
Colour rendering	80 Ra
Colour consistency	Within a six step Macadam ellipse
Rated peak intensity	1150cd
Rated beam angle	110°
Voltage / Frequency	240V~50Hz
Not suitable for accent lighting	

FIG 1 - Ceiling Insert Of The Panel Light

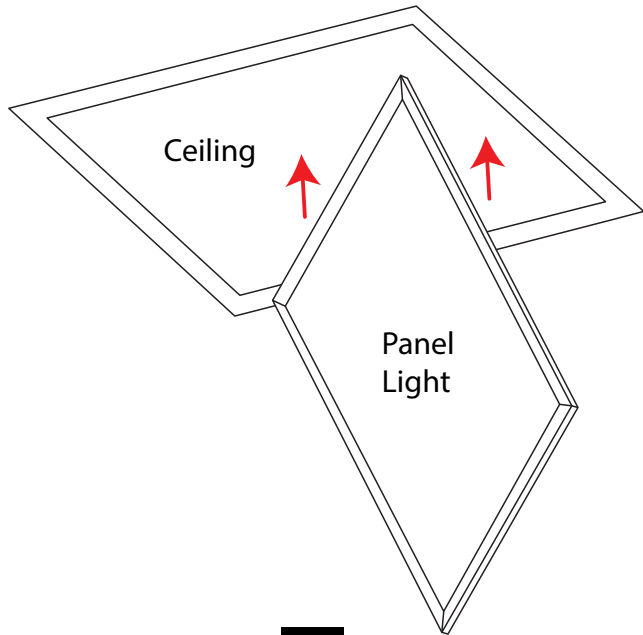

Fig 1

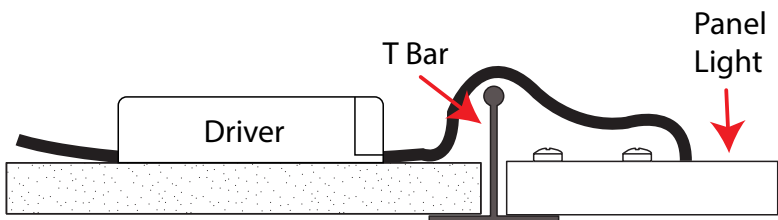
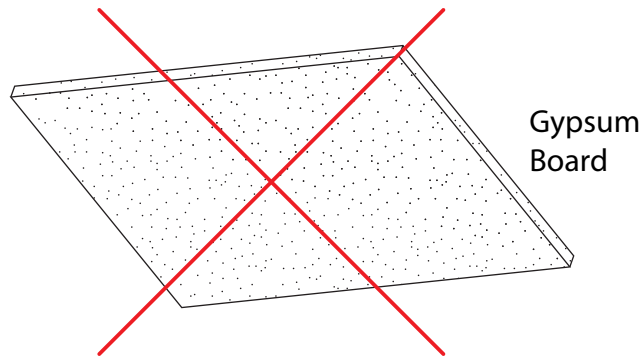

FIG 2 - Ceiling Hanging Of The Panel Light

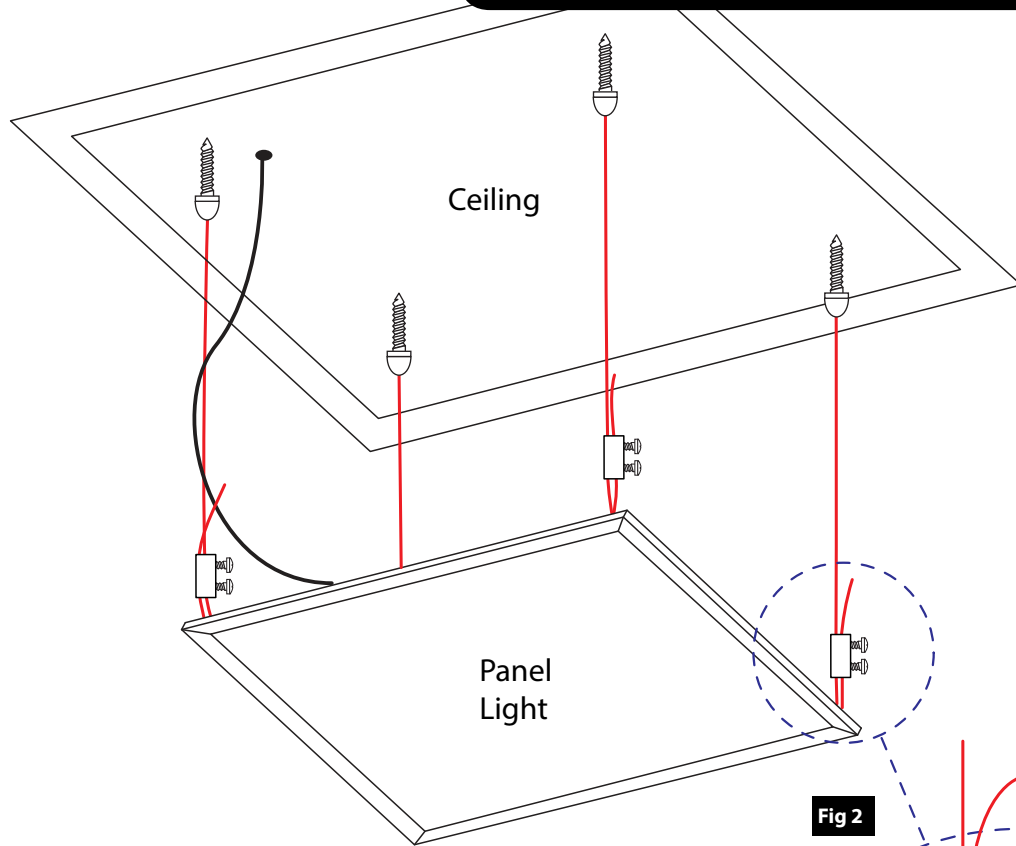
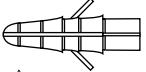

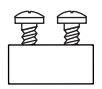

Fig 2

SUSPACK	
	X 4
	X 4
	X 4
1 x SUSPACK needed for 595x595mm Panel Light	

